



ALN-9940 “SQUIGGLE” INLAY

One of the most recognized & utilized inlays in RFID, ALN-9940 “Squiggle” by Alien Technology® combines proven multi-purpose application performance with the next generation high-memory RFID IC, Higgs™-9.



Applications

- Enterprise Wide Asset Management
- Volume Retail / Apparel
- Warehouse Management
- General Purpose Asset Tagging

FEATURE	DESCRIPTION	BENEFIT
One of the first & most reliable passive RFID inlays on the market	Deployment proven performance, optimized with the new Higgs-9 1024 bit memory footprint.	For applications requiring additional memory & sensitivity while providing fast & consistent ROI
Reliable read / write performance with Sentinel™ Memory	Bit error correction, proved read/write sensitivity, robust memory retention and 200,000 write cycles (2X that of competition)	Robust reliability of stored data & added protection against data loss/corruption.

Features:

- › Worldwide operation in all RFID UHF bands (860-960 MHz)
- › Global GS1 Class 1 Gen 2 (V1.2.0) and ISO/IEC 18000-6C compliance
- › Class leading read and write performance
- › 1024 bits of NVRAM Memory
 - Up to 496 EPC bits (96-bits nominal)
 - Up to 688 User Bits
 - 48 bit Unique TID
 - 32 bit Access and 32 bit Kill passwords
- › User Memory may be Block Perma-Locked as well as read password protected in 32 bit blocks
- › Low power operation for both read and write
- › *BlastWrite™* and *QuickWrite™* mass-encoding
- › Dynamic Authentication™ - anti-cloning/anti-counterfeit technology
- › Available in high-yield, high capacity dry/wet inlay rolls



Product Overview:

Optimized for next-generation high-memory & high-performance applications, the 94.80 x 8.15 mm **Higgs™-9 UHF RFID IC** based “**Squiggle**” **antenna design** continues the legacy of providing class leading performance in an inlay design suitable for numerous applications.

Applications include (but not limited to):

- Large memory enterprise wide asset management
- High volume retail & apparel tagging
- Warehouse management
- General purpose asset tagging

Enhanced memory footprint includes a **48-bit Unique TID for authentication** and **serialization** applications and **password protected read and write** support to prevent unauthorized viewing and modification of the tag’s data.

ALN-9940 inlays are World Tag compliant, enabling consistent operation across the diverse frequencies of the Americas, Europe, Middle East, Asia, and Africa.



ALN-9940 Inlay Orientation

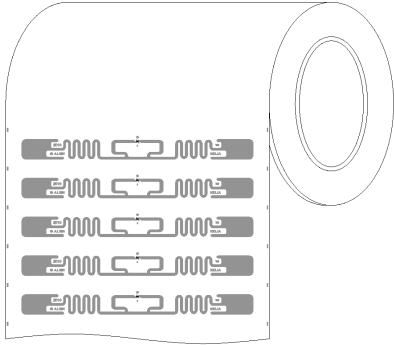

ALN-9940-R
(Dry Unslit Roll)

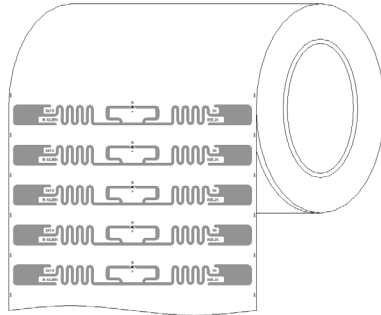

ALN-9940-SR
(Dry Slit Roll)

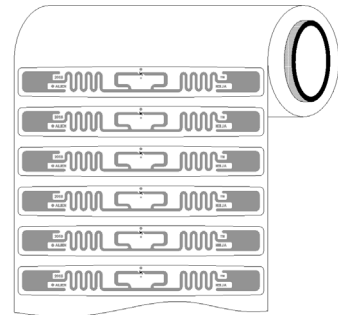

ALN-9940-WRC / -WRW
(Clear / White Wet Inlay)

Standard Alien Inlay rolls unwind with metal antenna side facing outward, with respect to the core.

ALN-9940 Inlay Specification

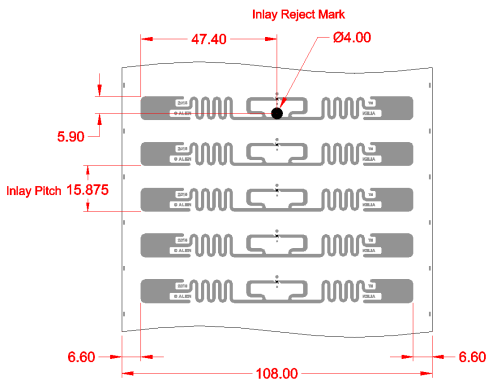

ALN-9940-R
(Dry Unslit Roll)

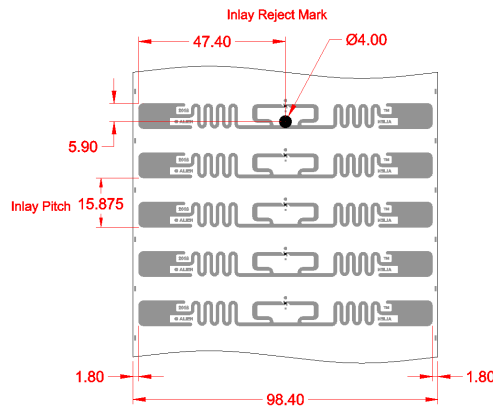

ALN-9940-SR
(Dry Slit Roll)

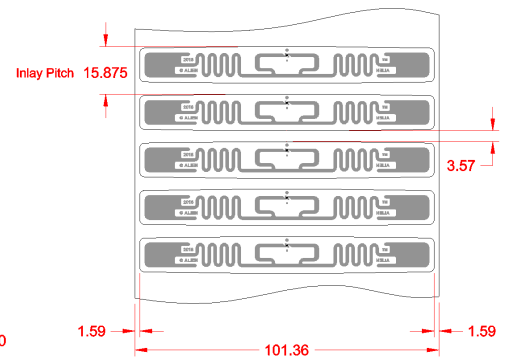

ALN-9940-WRC / -WRW
(Clear / White Wet Inlay)





ALN-9940 Inlay General Dimensions

DRY INLAY THICKNESS ±10%	
Over Antenna	0.06mm
Over Chip	0.24mm

CLEAR WET INLAY THICKNESS ±10%	
Over Antenna	0.08mm
Over Chip	0.24mm

WHITE WET INLAY THICKNESS ±10%	
Over Antenna	0.16mm
Over Chip	0.32mm



ALN-9940 Inlay Angular Sensitivity

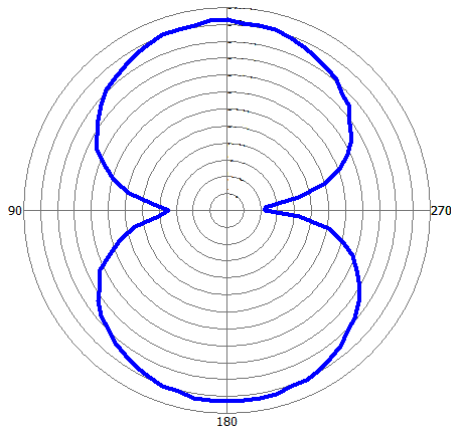

Angular Sensitivity
(Relative Read Range vs. Orientation)

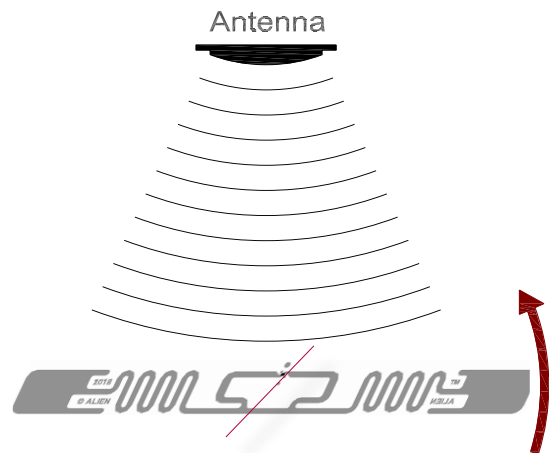

Angular Sensitivity
Inlay is rotated in the x, y, plane about the z axis



ALN 9940 Squiggle Inlay

ALN-9940 Specifications

Dry Inlay	
Antenna Width	3.732" [94.8mm]
Antenna Length	0.319" [8.1mm]
Web Width (-R)	4.252" [108.0mm]
Web Width (-SR)	3.874" [98.4mm]
Web Pitch	0.625" [15.875mm]
Core Width (-R)	4.252" [108.0mm]
Core Width (-SR)	3.874" [98.4mm]
Core ID	6" [152.4mm]*
Core Material	Fiberboard
Inlays per Roll (-R)	20,500 Nominal
Inlays per Roll (-SR)	30,500 Nominal
Maximum Roll OD	< 12" [304.8mm]
Roll Labeling Data	Roll #, Quantity

Wet Inlay	
Inlay Width	3.866" [98.2mm]
Inlay Length	0.484" [12.3mm]
Web Width	3.992" [101.4mm]
Web Pitch	0.625" [15.875mm]
Core Width	4.752" [120.7mm]
Core ID	6" [152.4mm]*
Core Material	Fiberboard
Inlays per Roll	20,500 Nominal
Maximum Roll OD	< 16" [406.4mm]
Roll Labeling Data	Roll #, Quantity
White (-WRW)	TT Printable White Film Overlay
Overlay Adhesive (-WRW)	General Purpose Permanent
Inlay Adhesive	General Purpose Permanent
Adhesive Application Temperature	> +25°F [-4°C]
Adhesive Service Temperature	-40°F to +200°F [-40°C to +93.3°C]
Release Liner	40# SCK

* Shipped with 6" to 3" plastic core adapter

Environmental	
Shelf Life	Dry Inlays: 5 years at +77°F [+25°C] @ 40% RH Wet Inlays: 2 years at +77°F [+25°C] @ 40% RH
Recommended Storage	+77°F [+25°C] @ 40% RH
Storage Limits	-13°F to 122°F [-25°C to +50°C] 20% to 90% RH Non-condensing
Operating Limits	-40°F to +158°F [-40°C to +70°C] 20% to 90% RH Non-condensing
Bend Diameter	> 1.97" [50mm]
Pressure	< 5N/mm ²
Drop Resistance	Per ASTM D5276
Write Cycles	200,000 @ 25°C
RoHs	2002/95/EC (RoHS 1), 2011/65/EU (RoHS 2), 2015/863 (RoHS 10)
REACH	EU 143/2011, EU 125/2012, Annex XIV of EC no. 1907/2006
ESD Limit- HBM / CDM	5.0kV / 1.5kV

RFID	
Protocols Supported	ISO/IEC 18000-6C EPCglobal Class 1 Gen 2
Integrated Circuit	Alien Higgs-9
Operating Frequency	840-960 MHz
EPC Size	96-496 Bits
User Memory	Up to 688 Bits
TID	32 Bits
Unique TID	48 Bits
Access Password	32 Bits
Kill Password	32 Bits

January 21, 2020

Copyright © 2020 Alien Technology LLC. All rights reserved.

Alien, Alien Technology, the Alien Technology logo, Spider, Higgs, Dynamic Authentication, QuickWrite, BlockWrite, Squiggle, and the Squiggle logo are trademarks or registered trademarks of Alien Technology Corporation in the U.S. and other countries.

HANDLING PRECAUTIONS Observe standard handling practices to minimize ESD.

DISCLAIMER Application recommendations are guidelines only - actual results may vary and should be confirmed. This is a general purpose product not designed or intended for any specific application.

This product is covered by one or more of the following U.S. patents: 7967204, 7931063, 7868766, 7737825, 7716208, 7716160, 7688206, 7659822, 7619531, 7615479, 7598867, 7580378, 7576656, 7562083, 7561221, 7559486, 7559131, 7554451, 7551141, 7542301, 7542008, 7531218, 7522055, 7500610, 7489248, 7453705, 7425467, 7417306, 7411503, 7385284, 7377445, 7364084, 7353598, 7342490, 7324061, 7321159, 7301458, 7295114, 7288432, 7265675, 7262686, 7260882, 7253735, 7244326, 7218527, 7214569, 7199527, 7193504, 7173528, 7172910, 7172789, 7141176, 7113250, 7101502, 7080444, 7070851, 7068224, 7046328, 6998644, 6988667, 6985361, 6980184, 6970219, 6952157, 6942155, 6933848, 6927085, 6816380, 6780696, 6731353, 6693384, 6683663, 6665044, 6657289, 6623599, 6606247, 6606079, 6590346, 6586338, 6566744, 6555408, 6527964, 6479395, 6468638, 6420266, 6316278, 6291896, 6281038. Other patents pending.

This product is licensed under patents of Round Rock Research, LLC, for use solely with UHF RFID Readers (such as Alien reader products) that are licensed under an agreement with Round Rock Research, LLC.



Alien Technology
845 Embedded Way
San Jose, CA 95138-1030
866-RFID NOW
www.alientechnology.com